

DALI DT6 Dimmer with Built-in Master Function

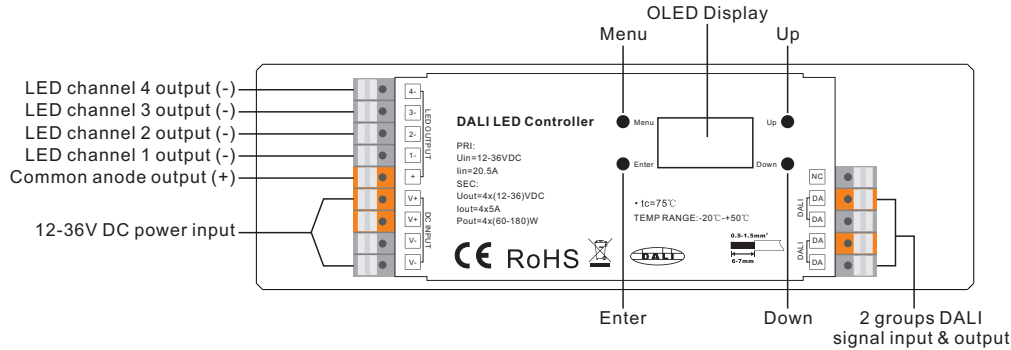

Important: Read All Instructions Prior to Installation

Function introduction



Product Data

No.	Input Voltage	Output Current	Output Power	DALI Consumption	Remarks	Size(LxWxH)	Ambient Temperature
1	12-36VDC	4x5A	4x(60-180)W	2mA	Constant voltage	170x53.4x28mm	-20°C ~ +50°C
2	12-48VDC	4x350mA	4x(4.2-16.8)W	2mA	Constant current	170x53.4x28mm	
3	12-48VDC	4x700mA	4x(8.4-33.6)W	2mA	Constant current	170x53.4x28mm	

- DALI DT6 dimmer, 4 channels PWM output, built-in DALI master function
- OLED display interface , easy & fast installation
- No DALI master required for configuration
- Cost & time saving than DALI USB configuration
- DALI address quantity 1-4 settable for 4 PWM outputs
- Enables to address & group 4 PWM outputs individually
- Enables to predefine & recall 16 DALI scenes to 4 PWM outputs individually
- Logarithmic/Linear dimming curve settable, match sensitivity of human eyes
- 250Hz-30KHz PWM frequency settable, flicker free, no noise
- Enables to set a min. level for dimming between this level to max. level
- Enables to manually set output level for 4 PWM outputs individually
- Enables to set fade Time, fade rate, power on level, system failure level
- Compatible with universal DALI masters that supports DT6 commands.

Safety & Warnings

- DO NOT install with power applied to device.
- DO NOT expose the device to moisture.

Commissioning and Configuration

Menu Select

After wiring the dimmer correctly, power on it, the OLED will show



means 4 PWM channels with 4 DALI addresses (00, 01, 02, 03) by factory default. Then click “Menu” button to enter Menu Select interface, keep clicking “Up” and “Down” buttons, you will get commissioning and configuration options one by one on the OLED display as follows:

- 1.Set Addr: assign DALI addresses to 4 PWM outputs
- 2.Set Group: assign 4 PWM outputs to one or more DALI groups
- 3.Save Scene: configure up to 16 scenes (0–15) to 4 PWM outputs
- 4.go to Scene: recall the configured 16 scenes to 4 PWM outputs
- 5.Set Dir Power: set out level of 4 PWM outputs manually
- 6.Set curve: set the dimming curve
- 7.Set Time Rate: set fade time and fade rate
- 8.Set Power Min: set a minimum level, the dimmer can not be dimmed below this value
- 9.Set Power on: set a level as the value after power is restored
- 10.Set Sys fail: set a level as the value in the event of failure of the DALI power supply
- 11.Set Channel: set DALI address quantity for 4 PWM outputs
- 12.Set Zero Addr: set the starting DALI address as 0/1
- 13.Set PWM freq: set the output PWM frequency
- 14.Reset: factory reset the dimmer

Set Channel

Before commissioning and configuration, please first set DALI address quantity for the 4 PWM outputs:

1)Click “Up” and “Down” button on Menu select interface to select “11.set Channel”

2)Click “Enter” button to enter set channel interface, click “Enter” button move the cursor to the digit after “Total ch:”, then click “Up” and “Down” buttons to select 4/3/2/1 DALI addresses for 4 PWM outputs, then click “Enter” button to confirm setting, factory default is 4.

Note:

- When set channel as 4, 4 PWM outputs will be assigned with 4 different DALI addresses. (In the following commissioning and configuration instructions, “Addr all” means 4 PWM outputs will be configured together, “Addr 1” is to configure PWM output 1, “Addr 2” is to configure output 2, “Addr 3” is to configure output 3, “Addr 4” is to configure output 4.)
- When set channel as 3, PWM outputs 1-3 will be assigned with 3 different DALI addresses, and PWM output 4 will be assigned with the same address as output 3. (In the following commissioning and configuration instructions, “Addr all” means 4 PWM outputs will be configured together, “Addr 1” is to configure PWM output 1, “Addr 2” is to configure output 2, “Addr 3” is to configure outputs 3&4.)
- When set channel as 2, 2 DALI addresses will be assigned to 4 PWM outputs, one for PWM outputs 1&3, the other for PWM outputs 2&4. (In the following commissioning and configuration instructions, “Addr all” means 4 PWM outputs will be configured together, “Addr 1” is to configure PWM outputs 1&3, “Addr 2” is to configure outputs 2&4.)
- When set channel as 1, PWM outputs 1-4 will be assigned with one DALI address, all outputs will be controlled simultaneously. (In the following commissioning and configuration instructions, “Addr 1” means 4 PWM outputs will be configured together.)

Set zero Addr

This configuration is to set the starting DALI address according to different DALI systems:

● Menu  Up ● 1)Click “Menu” button to return to Menu select interface, click “Up” and “Down” buttons to select “12. set zero Addr”

● Enter  Down ●

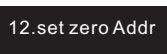
● Menu  Up ● 2)Click “Enter” button to enter set zero address interface, then click “Enter” button to move the cursor to the digit “0” after “zero Addr:”, click “Up” and “Down” to select 0/1, then click “Enter” to confirm setting and the cursor will move to “zero Addr:”.

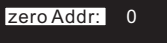
● Enter  Down ●

0 means starting DALI address is 00, and DALI address range will be 00-63.

1 means starting DALI address is 01, and DALI address range will be 01-64.

Note:

- By factory default, the starting DALI address is 00.

Set Addr

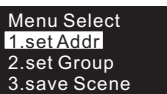
● Menu  Up ● 1)Once DALI address quantity is set, click “Menu” button to return to Menu select interface, click “Up” and “Down” buttons to select “1. set Addr”

● Enter  Down ●

2)Click “Enter” button to enter set address interface, there will be 4 addresses for 4 PWM outputs respectively:

3)Click “Enter” button move the cursor to the first digit after “Addr 1:”, then click “Up” and “Down” buttons to select a digit, then click “Enter” to confirm and move the cursor to the second digit, then select a digit by clicking

“Up” and “Down” buttons, then click “Enter” button to confirm setting, and the cursor will be moved to Addr 1.

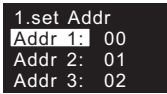
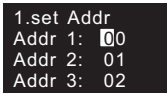
● Menu  Up ● ● Menu  Up ● 4)Click “Down” button to move the cursor to Addr 2, Addr 3, Addr 4, and set the addresses following the same instructions as Addr 1.

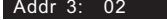
● Enter  Down ● ● Enter  Down ●

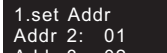
● Menu  Up ●

● Enter  Down ●

Note:

- DALI address is settable from 00-63-FF, and factory default DALI addresses for 4 PWM outputs are 00, 01, 02, 03 respectively. FF means no address assigned.

Set Group

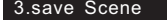

● Menu  Up ● 1)Click “Menu” button to return to Menu select interface, click “Up” and “Down” buttons to select “2. set Group”

● Enter  Down ●

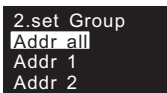
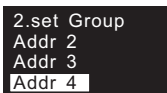

2)Click “Enter” button to enter set group interface, we can group 4 PWM outputs together to the same groups by setting “Addr all”, also we can group the 4 PWM outputs separately by setting “Addr 1”, “Addr 2”, “Addr 3”, “Addr 4”, click “Up” and “Down” button to select Addr all/1/2/3/4, then click “Enter” button to enter the group setting interface:

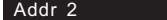
3)The 4 PWM outputs can be assigned to total 16 groups (G0-G15). Click “Enter” to move the cursor to the digit after “G0:”, click “Up” and “Down” to select 0/1, 0 means the selected PWM output(s) does not belong to this group, and 1 means it belongs to the group, then click “Enter” button to confirm setting and move the cursor to “G0”.

● Menu  Up ● ● Menu  Up ● 4)Click “Down” button to move the cursor to G1-G15, and set the groups following the same instructions as G0.

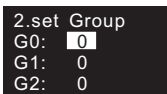
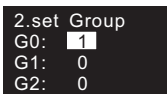
● Enter  Down ● ● Enter  Down ●

● Menu  Up ● ● Menu  Up ●

● Enter  Down ● ● Enter  Down ●

Note:

- The 4 PWM outputs can be assigned to total 16 groups (G0-G15) together or respectively. By factory default they do not belong to any of the groups.

Save Scene

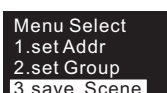
● Menu  Up ● 1)Click “Menu” button to return to Menu select interface, click “Up” and “Down” buttons to select “3. save Scene”

● Enter  Down ●

2)Click “Enter” button to enter save scene interface, we can configure total 16 scenes (S0-S15) to 4 PWM outputs together by setting “Addr 1”, “Addr 2”, “Addr 3”, “Addr 4”, click “Up”

and "Down" button to select Addr all/1/2/3/4, then click "Enter" button to enter the scene setting interface:

3)Total 16 scenes can be configured. Click "Enter" to move the cursor to the 1st digit after "S0:", click "Up" and "Down" to select a digital, then click "Enter" to confirm and move the cursor to 2nd digit and set, then 3rd digit, the scene value is settable from 000(0%)-254(100%)-255(MASK), then click "Enter" button to confirm setting and move the cursor to "S0".

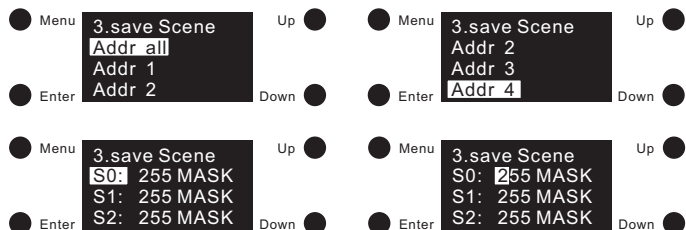

4)Click "Down" button to move the cursor to S1-S15, and set the scenes following the same instructions as S0.

Note:

- The scene value is settable from 000(0%)-254(100%)-255(MASK)
- By factory default, the value for all 16 scenes is 255 MASK, which means the PWM outputs will retain their current intensity when relevant scene is recalled.

go to Scene

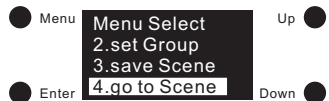

1)Click "Menu" button to return to Menu select interface, click "Up" and "Down" buttons to select "4. go to scene"

2)Click "Enter" button to enter get Scene interface, we can recall total 16 configured scenes (scene0-scene15) to 4 PWM outputs together by setting "Addr all", or separately by setting "Addr 1", "Addr 2", "Addr 3", "Addr 4", click "Up" and "Down" button to select Addr all/1/2/3/4, then click "Enter" button to enter the get Scene interface:

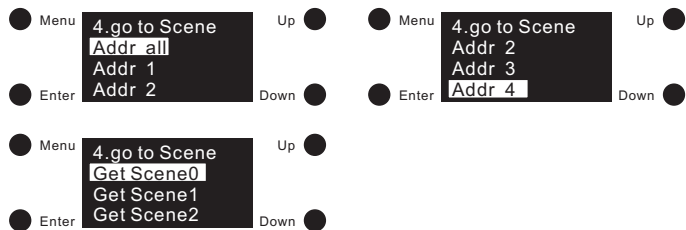

3)Total 16 scenes can be recalled (Get scene0 – Get scene15), click "Up" and "Down" buttons to select from Get scene0 to Get scene15, then click "Enter" button to confirm and recall corresponding scene.

Note:

- By factory default, the value for all 16 scenes is 255 (MASK), which means the PWM outputs will retain their current intensity when a scene is recalled.

Set Dir Power

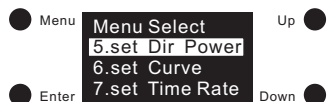

1)This configuration is to set out level of 4 PWM outputs manually. Click "Menu" button to return to Menu select interface, click "Up" and "Down" buttons to select "5. set Dir Power"

2)Click "Enter" button to enter set Dir Power interface, we can set out level of 4 PWM outputs together by setting "Addr all", or separately by setting "Addr 1", "Addr 2", "Addr 3", "Addr 4", click "Up" and "Down" button to select Addr all/1/2/3/4, then click "Enter" button to enter the configuration interface:

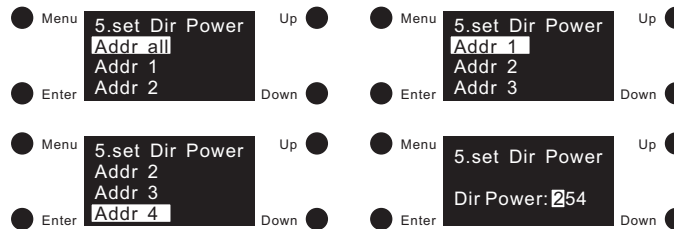

3)Click "Enter" to move the cursor to the 1st digit after "Dir Power:", click "Up" and "Down" to select a digital, then click "Enter" to confirm and move the cursor to 2nd digit and set, then 3rd digit, the out level value is settable from 000-254 (0%-100%), then click "Enter" button to move the cursor to "Dir Power" and confirm setting.

Note:

- The out level value is settable from 000-254 (0%-100%)
- By factory default, the out level value is 254 (100%).

Set Curve

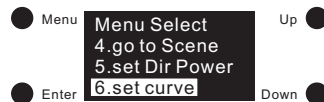

1)This configuration is to set dimming curve. Click "Menu" button to return to Menu select interface, click "Up" and "Down" buttons to select "6. set Curve"

2)Click "Enter" button to enter set Curve interface, then click "Enter" button to move the cursor to the digit "0" after "Dim curve", click "Up" and "Down" to select 0/1, then click "Enter" to confirm setting and the cursor will move to "Dim curve".

3)0 means linear, and 1 means logarithmic.



Note:

- By factory default, the dimming curve is 1 (logarithmic).
- **linear:** the luminous flux is changed linearly during smooth adjustment. This does not match the sensitivity of the human eye and might not be perceived as smooth.
- **logarithmic:** the luminous flux of the luminaire is changed logarithmically during smooth adjustment as per the DALI specification. This matches the sensitivity of the human eye and is therefore perceived as smooth.

Set PWM freq

1)This configuration is to set PWM output frequency. Click "Menu" button to return to Menu select interface, click "Up" and "Down" buttons to select "13. set PWM freq"

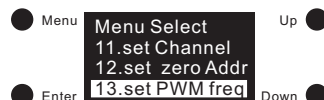

2)Click “Enter” button to enter set PWM frequency interface, then click “Enter” button to move the cursor to the digit “0” after “freq:”, click “Up” and “Down” to select from 00-11 (250Hz-30KHz), then click “Enter” to confirm setting and the cursor will move to “freq:”. Detailed PWM frequency setting are as follows:

Number	00	01	02	03	04	05	06	07	08	09	10	11
Frequency	250Hz	500Hz	1KHz	2KHz	3KHz	4KHz	5KHz	10KHz	15KHz	20KHz	25KHz	30KHz

3)“Mode” is for setting dimming mode. Two modes are selectable: positive dimming and negative dimming. Click “down” button to move the cursor to “mode”, then click “enter” button to move the cursor to “0” after “mode” and then “Up” and “Down” to select “0/1”, then click “Enter” button to confirm.

0 is positive dimming and under this mode when DALI value changes from 000 to 254, the light intensity will go from 0% to 100%.

1 is negative dimming and under this mode when DALI value changes from 000 to 254, the light intensity will go from 100% to 0%.

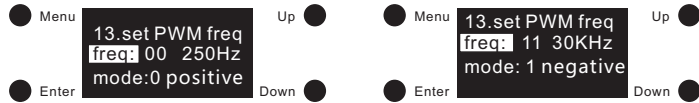

Note:

- By factory default, the PWM output frequency is 00 (250Hz).
- By factory default, the dimming mode is 0 positive dimming.

Setting DALI default parameters

The following DALI default parameters can be set:

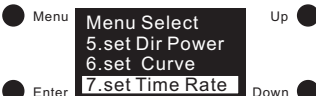
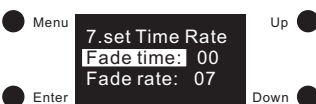
DALI default parameters	Description
Fade time	<p>1)Click “Menu” button to return to Menu select interface, click “Up” and “Down” buttons to select “7. set Time Rate”</p>  <p>2)Click “Enter” button to enter set Fade time and Fade rate interface, then click “Enter” button to move the cursor to the 1st digit after “Fade time:”, click “Up” and “Down” to select a digit, then click “Enter” to confirm setting and move the cursor to 2nd digit and set, then click “Enter” to confirm and the cursor will be moved to “Fade time:”.</p>  <p>3)The selected value is set as the fade time in seconds. Value range: • 00–15 s Note: 00 s is the DALI default. 00 s is the fastest fade time, and 15 s is the slowest.</p>

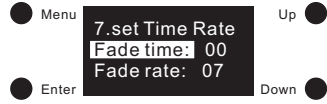
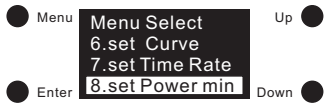
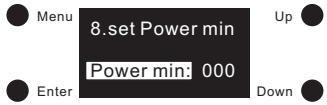
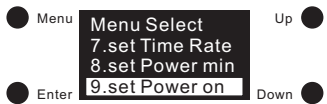
Fade rate	<p>1)On set Time Rate interface, after setting the Fade time, click “Down” button to move the cursor to “Fade rate:”, then click “Enter” button to move the cursor to the 1st digit after “Fade rate:”, click “Up” and “Down” to select a digit, then click “Enter” to confirm setting and move the cursor to 2nd digit and set, then click “Enter” to confirm and the cursor will be moved to “Fade rate:”</p>  <p>2)The selected value is set as the dimming speed. It indicates by how many steps per second the intensity is changed. The Fade Rate is used with the DALI commands Brighten (Up) and Dim (Down). Value range: • 01–15 steps per second Note: 07 steps per second is the DALI default. 15 steps per second is the fastest fade rate, and 01 steps per second is the slowest.</p>
Minimum level	<p>1)Click “Menu” button to return to Menu select interface, click “Up” and “Down” buttons to select “8. set Power min”</p>  <p>2)Click “Enter” button to enter set Minimum level interface, click “Enter” to move the cursor to the 1st digit after “Power min:”, click “Up” and “Down” to select a digit, then click “Enter” to confirm and move the cursor to 2nd digit and set, then 3rd digit, the minimum level is settable from 000 (0%)-250 (98.4%), then click “Enter” button to move the cursor to “Power min:” and confirm setting.</p>  <p>3)The selected value is set as the minimum level for the control gear. This value cannot be fallen below during dimming/brightening. Value range: • 000 (0%)-250 (98.4%) Note: 000 (0%) is the factory default minimum level.</p>
Power On Level	<p>1)Click “Menu” button to return to Menu select interface, click “Up” and “Down” buttons to select “9. set Power on”</p>  <p>2)Click “Enter” button to enter set Minimum level interface, click “Enter” to move the cursor to the 1st digit after “Power on:”, click “Up” and “Down” to select a digit, then click “Enter” to confirm and move the cursor to 2nd digit and set, then 3rd digit, the minimum level is settable from 000 (0%) – 254 (100%) – 255 (MASK), then click</p>

"Enter" button to move the cursor to "Power on:" and confirm setting.

● Menu 9.set Power on Up ●
 ● Enter Power on: 254 Down ●

Power On Level

3)The selected value is set as the value after power is restored.
Value range:

- 000 (0%) – 254 (100%)
- 255 (MASK)

Note: 254 (100%) is the factory default power on level. 255 (MASK) means the PWM outputs will retain their current intensity after power is restored.

1)Click "Menu" button to return to Menu select interface, click "Up" and "Down" buttons to select "10. set Sys fail"

● Menu Menu Select 8.set Power min 9.set Power on Up ●
 ● Enter 10.set Sys fail Down ●

2)Click "Enter" button to enter set System failure level interface, click "Enter" to move the cursor to the 1st digit after "Sys fail:", click "Up" and "Down" to select a digital, then click "Enter" to confirm and move the cursor to 2nd digit and set, then 3rd digit, the minimum level is settable from 000 (0%) – 254 (100%) – 255 (MASK), then click "Enter" button to move the cursor to "Sys fail:" and confirm setting.

● Menu 10.set Sys fail Up ●
 ● Enter Sys fail: 254 Down ●

System Failure Level

3)The selected value is set as the value in the event of failure of the DALI power supply.
Value range:

- 000 (0%) – 254 (100%)
- 255 (MASK)

Note: 254 (100%) is the factory default System Failure Level. 255 (MASK) means the PWM outputs will retain their current intensity in the event of failure of the DALI power supply.

Reset

1)This setting is to factory reset the device. Click "Menu" button to return to Menu select interface, click "Up" and "Down" buttons to select "14. Reset"

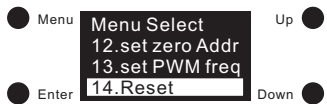

2)Click "Enter" button to enter factory reset interface, click "Up" and "Down" button to move the cursor from "Abort" to "OK", "Abort" means cancelling the reset, "OK" means confirming the reset, then click "Enter" button

to confirm the reset, then the display will flash "Restoring to default setting" and restart which means the reset is successful.

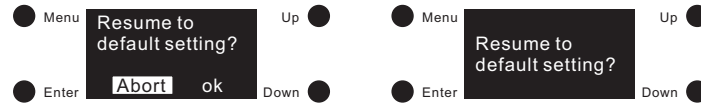

Wiring Diagram

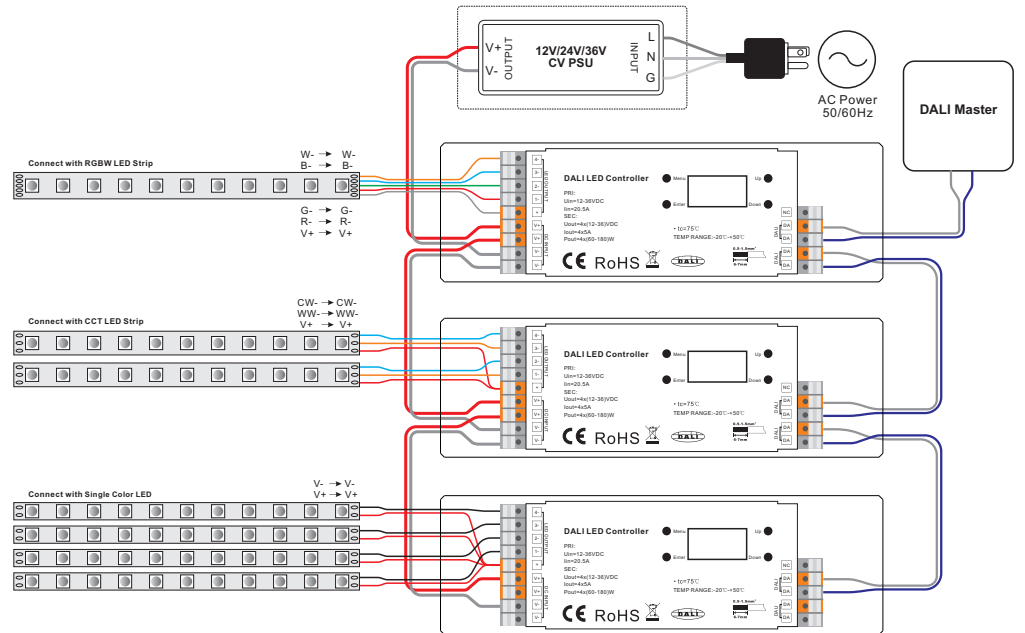

Product Dimension

