







LED Profil SLI | max. LED Leistung pro Meter: 55W → 3 x Flexstrip 75 oder 2 x Flexstrip 108

ALUMINIUM PROFILE & ABDECKUNGEN ALUMINIUM PROFILES & COVERS	
 <p>AP-003-003 Aluminium Profil SLI Aluminium profile SLI</p>	 <p>AB-003-100 Aluminium Abdeckung SL Aluminium cover SL</p>

PROFIL ABDECKUNGEN UND EINSCHÜBE PROFILE COVERS AND INSETS		
<p>$\eta \approx 73\%$</p>  <p>AB-003-001 PMMA Abdeckung SL Flach Transparent PMMA cover SL flat transparent</p>	<p>$\eta \approx 60\%$</p>  <p>AB-003-003 PMMA Abdeckung SL Flach Opal PMMA cover SL flat milky</p>	<p>$\eta \approx 64\%$</p>  <p>AB-003-006 PMMA Abdeckung SL Rund Opal PMMA cover SL round milky</p>
<p>$\eta \approx 66\%$</p>  <p>AB-003-009 PMMA Abdeckung SL Eckig Opal PMMA cover SL square milky</p>	<p>Transparente Abdeckung erforderlich Transparent cover necessary</p> <p>$\eta \approx 64\%$</p>  <p>MP-003-001 Mikroprism. Einschub SL Transparent Microprismatic Inset SL transparent</p>	<p>Transparente Abdeckung erforderlich Transparent cover necessary</p> <p>$\eta \approx 61\%$</p>  <p>MP-003-003 Mikroprism. Einschub SL Opal Microprismatic Inset SL milky</p>

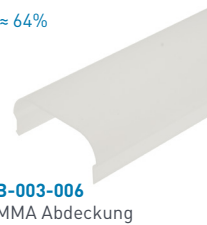
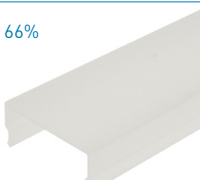
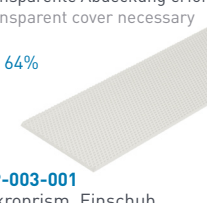
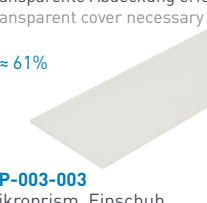
PROFIL ENDKAPPEN PROFILE ENDCAPS		
<p>Endkappenstärke End cap thickness 2,5mm</p>  <p>EK-003-300 Profil Endkappe SLI Flach geschlossen Profile endcap SLI flat closed</p>	<p>Endkappenstärke End cap thickness 2,5mm</p>  <p>EK-003-310 Profil Endkappe SLI Rund geschlossen Profile endcap SLI round closed</p>	<p>Endkappenstärke End cap thickness 2,5mm</p>  <p>EK-003-320 Profil Endkappe SLI Eckig geschlossen Profile endcap SLI square closed</p>

<p>Netzteile mit max. 52mm Breite und 32mm Höhe im Profil integrierbar</p> <p>Aluminium Abdeckung SL erforderlich!</p>		<p>Power Supplies with max. 52mm width and 32mm height profile integrable</p> <p>aluminum cover SL required!</p>
--	---	--

1m	2m	4m	SONDER LÄNGE	SPECIAL LENGTH
----	----	----	--------------	----------------

STANDARDLÄNGE = 2M | ALLE ANDEREN LÄNGEN SIND VOM UMTAUSCH UND DER RÜCKGABE AUSGESCHLOSSEN. LÄNGEN ÜBER 2M WERDEN MITTELS SPEDITION VERSENDET UND ERFORDERN EINE MINDESTBESTELLMENGE VON 10 STK.

STANDARD LENGTH = 2M | ALL OTHER LENGTHS ARE EXCLUDED FROM EXCHANGE AND RETURN. LENGTHS OVER 2M ARE SHIPPED BY FREIGHT CARRIER AND REQUIRE A MINIMUM ORDER QUANTITY OF 10 PCS.

HINWEIS PLEASE NOTE



Kunststoff und Aluminium besitzen unterschiedliche Ausdehnungskoeffizienten, welche bei der Montage zu berücksichtigen sind. Ausgehend von 20 °C verändert sich die Länge beim Aluminium um ca. 0,25mm pro Meter und beim Kunststoff um ca. 0,70mm pro Meter je 10 °C Temperaturunterschied.

Plastic and aluminium have different expansion coefficients, which must be considered during assembly. Based on 20 °C the length of aluminium changes approximately 0,25mm per meter and plastic approximately 0,70 mm per meter per 10 °C of difference in temperature.

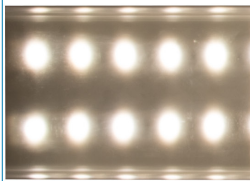
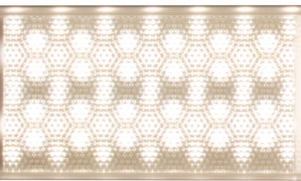

PROFIL ZUBEHÖR | PROFILE ACCESSORIES

 <p>PZ-003-002 Einbau Montagewinkel SLI Mounting angle SLI</p>	 <p>EK-100-002 Torx Bit TX8 für Endkappenschrauben Torx Bit TX8 for endcap screws</p>	 <p>PZ-006-001 Saugnapf 30mm Suction cup 30mm</p>
--	---	---

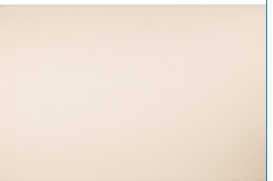

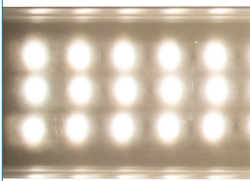
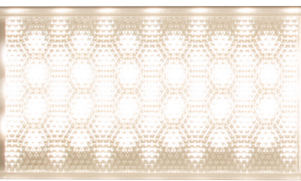

SLI PROFIL BESTÜCKT MIT 2 X FLEXSTRIP 72 MIT EINEM LED ABSTAND VON 16,5MM IN KOMBINATION MIT DEN UNTERSCHIEDLICHEN ABDECKUNGEN
SLI PROFILE FITTED WITH 2 X FLEXSTRIP 72 WITH A LED DISTANCE OF 16,5MM IN COMBINATION WITH THE DIFFERENT COVERS

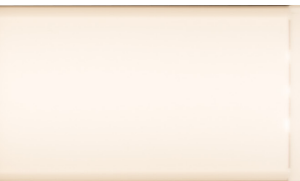
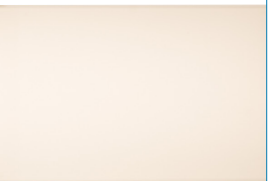
<p>PMMA Abdeckung SL Flach Transparent 91% Transmission</p> 	<p>PMMA Abdeckung SL Flach Transp. 91% Transmission + Mikroprismatik Transp. 95% Transmission</p> 	<p>PMMA Abdeckung SL Flach Transp. 91% Transmission + Mikroprismatik Opal 93% Transmission</p> 	<p>PMMA Abdeckung SL Flach Opal 76% Transmission</p> 	<p>PMMA Abdeckung SL Eckig Opal 76% Transmission</p> 
<p>PMMA cover SL flat transparent 91% transmission</p>	<p>PMMA cover SL flat transparent 91% transmission + Microprismatic transparent 95% transmission</p>	<p>PMMA cover SL flat transparent 91% transmission + Microprismatic milky 93% transmission</p>	<p>PMMA cover SL flat milky 76% transmission</p>	<p>PMMA cover SL square milky 76% transmission</p>

SLI PROFIL BESTÜCKT MIT 3 X FLEXSTRIP 72 MIT EINEM LED ABSTAND VON 16,5MM IN KOMBINATION MIT DEN UNTERSCHIEDLICHEN ABDECKUNGEN
SLI PROFILE FITTED WITH 3 X FLEXSTRIP 72 WITH A LED DISTANCE OF 16,5MM IN COMBINATION WITH THE DIFFERENT COVERS

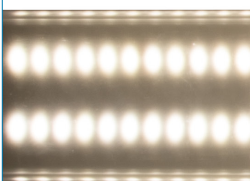
<p>PMMA Abdeckung SL Flach Transparent 91% Transmission</p> 	<p>PMMA Abdeckung SL Flach Transp. 91% Transmission + Mikroprismatik Transp. 95% Transmission</p> 	<p>PMMA Abdeckung SL Flach Transp. 91% Transmission + Mikroprismatik Opal 93% Transmission</p> 	<p>PMMA Abdeckung SL Flach Opal 76% Transmission</p> 	<p>PMMA Abdeckung SL Eckig Opal 76% Transmission</p> 
<p>PMMA cover SL flat transparent 91% transmission</p>	<p>PMMA cover SL flat transparent 91% transmission + Microprismatic transparent 95% transmission</p>	<p>PMMA cover SL flat transparent 91% transmission + Microprismatic milky 93% transmission</p>	<p>PMMA cover SL flat milky 76% transmission</p>	<p>PMMA cover SL square milky 76% transmission</p>

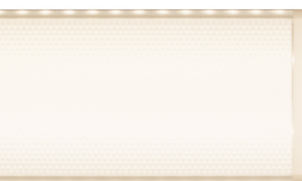
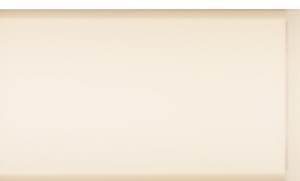
SLI PROFIL BESTÜCKT MIT 2 X FLEXSTRIP 48 ODER 72 DW MIT EINEM LED ABSTAND VON 7,15MM IN KOMBINATION MIT DEN UNTERSCH. ABDECKUNGEN
SLI PROFILE FITTED WITH 2 X FLEXSTRIP 48 OR 72 DW WITH A LED DISTANCE OF 7,15MM IN COMBINATION WITH THE DIFFERENT COVERS

<p>PMMA Abdeckung SL Flach Transparent 91% Transmission</p> 	<p>PMMA Abdeckung SL Flach Transp. 91% Transmission + Mikroprismatik Transp. 95% Transmission</p> 	<p>PMMA Abdeckung SL Flach Transp. 91% Transmission + Mikroprismatik Opal 93% Transmission</p> 	<p>PMMA Abdeckung SL Flach Opal 76% Transmission</p> 	<p>PMMA Abdeckung SL Eckig Opal 76% Transmission</p> 
<p>PMMA cover SL flat transparent 91% transmission</p>	<p>PMMA cover SL flat transparent 91% transmission + Microprismatic transparent 95% transmission</p>	<p>PMMA cover SL flat transparent 91% transmission + Microprismatic milky 93% transmission</p>	<p>PMMA cover SL flat milky 76% transmission</p>	<p>PMMA cover SL square milky 76% transmission</p>