

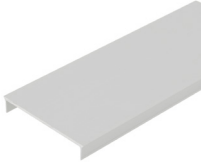

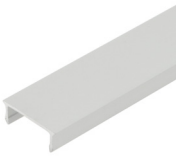



# LED Profil SLR | max. LED Leistung pro Meter: 65W → 3 x Flexstrip 75 oder 2 x Flexstrip 108 + 1 x Flexstrip 75

ALUMINIUM PROFILE & ABDECKUNGEN   ALUMINIUM PROFILES & COVERS		
 <p><b>AP-003-001</b> Aluminium Profil SLR Aluminium profile SLR</p>	 <p><b>AB-003-100</b> Aluminium Abdeckung SL Aluminium cover SL</p>	 <p><b>AB-001-100</b> Aluminium Abdeckung LB Aluminium cover LB</p>

PROFIL ABDECKUNGEN UND EINSCHÜBE   PROFILE COVERS AND INSETS		
<p><math>\eta \approx 73\%</math></p>  <p><b>AB-003-001</b> PMMA Abdeckung SL Flach Transparent PMMA cover SL flat transparent</p>	<p><math>\eta \approx 60\%</math></p>  <p><b>AB-003-003</b> PMMA Abdeckung SL Flach Opal PMMA cover SL flat milky</p>	<p><math>\eta \approx 64\%</math></p>  <p><b>AB-003-006</b> PMMA Abdeckung SL Rund Opal PMMA cover SL round milky</p>
<p><math>\eta \approx 66\%</math></p>  <p><b>AB-003-009</b> PMMA Abdeckung SL Eckig Opal PMMA cover SL square milky</p>	<p>Transparente Abdeckung erforderlich Transparent cover necessary</p> <p><math>\eta \approx 64\%</math></p>  <p><b>MP-003-001</b> Mikroprism. Einschub SL Transparent SL transparent</p>	<p>Transparente Abdeckung erforderlich Transparent cover necessary</p> <p><math>\eta \approx 61\%</math></p>  <p><b>MP-003-003</b> Mikroprism. Einschub SL Opal Microprismatic Inset SL milky</p>
<p><math>\eta \approx 90\%</math> indirekt   indirect</p>  <p><b>AB-001-001</b> PMMA Abdeckung LB Flach Transparent PMMA cover LB flat transparent</p>	<p><math>\eta \approx 66\%</math> indirekt   indirect</p>  <p><b>AB-001-003</b> PMMA Abdeckung LB Flach Opal PMMA cover LB flat milky</p>	

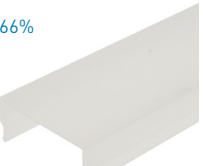
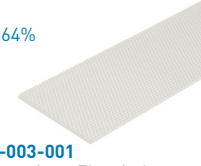
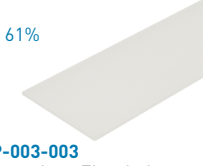
PROFIL ENDKAPPEN   PROFILE ENDCAPS		
<p>Endkappenstärke   End cap thickness 2,5mm</p>  <p><b>EK-003-100</b> Profil Endkappe SLR Flach geschlossen Profile endcap SLR flat closed</p>	<p>Endkappenstärke   End cap thickness 2,5mm</p>  <p><b>EK-003-110</b> Profil Endkappe SLR Rund geschlossen Profile endcap SLR round closed</p>	<p>Endkappenstärke   End cap thickness 2,5mm</p>  <p><b>EK-003-120</b> Profil Endkappe SLR Eckig geschlossen Profile endcap SLR square closed</p>

- 1m
- 2m
- 4m
- SONDER LÄNGE
- SPECIAL LENGTH

STANDARDLÄNGE = 2M | ALLE ANDEREN LÄNGEN SIND VOM UMTAUSCH UND DER RÜCKGABE AUSGESCHLOSSEN. LÄNGEN ÜBER 2M WERDEN MITTELS SPEDITION VERSENDET UND ERFORDERN EINE MINDESTBESTELLMENGE VON 10 STK.









STANDARD LENGTH = 2M | ALL OTHER LENGTHS ARE EXCLUDED FROM EXCHANGE AND RETURN. LENGTHS OVER 2M ARE SHIPPED BY FREIGHT CARRIER AND REQUIRE A MINIMUM ORDER QUANTITY OF 10 PCS.

## HINWEIS PLEASE NOTE

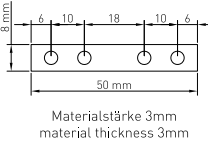

Kunststoff und Aluminium besitzen unterschiedliche Ausdehnungskoeffizienten, welche bei der Montage zu berücksichtigen sind. Ausgehend von 20°C verändert sich die Länge beim Aluminium um ca. 0,25mm pro Meter und beim Kunststoff um ca. 0,70mm pro Meter je 10°C Temperaturunterschied.

Plastic and aluminium have different expansion coefficients, which must be considered during assembly. Based on 20°C the length of aluminium changes approximately 0,25mm per meter and plastic approximately 0,70 mm per meter per 10°C of difference in temperature.

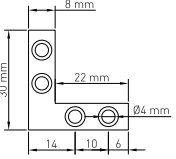

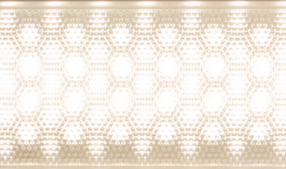

# LED Profile SLR | max. LED power per meter: 55W → 3 x Flexstrip 75 or 2 x Flexstrip 108 + 1 x Flexstrip 75

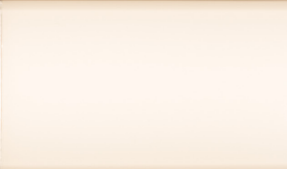
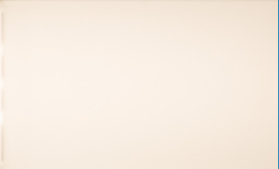
PROFIL ZUBEHÖR   PROFILE ACCESSORIES				
 <p><b>PZ-001-002</b> Seilabhänger 2m inkl. Deckenbefestigung Wire suspension 2m incl. ceiling fixture</p>	 <p><b>PZ-001-005</b> Seilabhänger 5m inkl. Deckenbefestigung Wire suspension 5m incl. ceiling fixture</p>	 <p><b>PZ-002-003</b> Seilstopper mit Y-Aufhängung 120mm Seil 4mm Kugeln Wire stopper with Y-suspension 120mm wire 4mm rolls</p>	 <p><b>EK-100-002</b> Torx Bit TX8 für Endkappenschrauben Torx Bit TX8 for endcap screws</p>	
 <p><b>PZ-006-001</b> Saugnapf 30mm Suction cup 30mm</p>	 <p><b>PZ-004-001</b> Profilverbinder SLR Profile connector SLR</p> <p>Für 1 Profilverbindung sind 2 Stück Verbinder notwendig For 1 profile connection 2 pieces connectors necessary</p>  <p>Materialstärke 3mm material thickness 3mm</p>	 <p><b>PZ-004-004</b> Eck Profilverbinder SLR Corner Profile connector SLR</p> <p>Für 1 Profilverbindung sind 2 Stück Verbinder notwendig For 1 profile connection 2 pieces connectors necessary</p>  <p>Materialstärke 3mm material thickness 3mm</p>		

## SLR PROFIL BESTÜCKT MIT 3 X FLEXSTRIP 72 MIT EINEM LED ABSTAND VON 16,5MM IN KOMBINATION MIT DEN UNTERSCHIEDLICHEN ABDECKUNGEN SLR PROFILE FITTED WITH 3 X FLEXSTRIP 72 WITH A LED DISTANCE OF 16.5MM IN COMBINATION WITH THE DIFFERENT COVERS

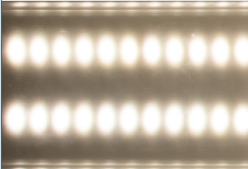
PMMA Abdeckung SL Flach Transparent 91% Transmission	PMMA Abdeckung SL Flach Transp. 91% Transmission + Mikroprismatik Transp. 95% Transmission	PMMA Abdeckung SL Flach Transp. 91% Transmission + Mikroprismatik Opal 93% Transmission	PMMA Abdeckung SL Flach Opal 76% Transmission	PMMA Abdeckung SL Eckig Opal 76% Transmission
				
PMMA cover SL flat transparent 91% transmission	PMMA cover SL flat transparent 91% transmission + Microprismatic transparent 95% transmission	PMMA cover SL flat transparent 91% transmission + Microprismatic milky 93% transmission	PMMA cover SL flat milky 76% transmission	PMMA cover SL square milky 76% transmission

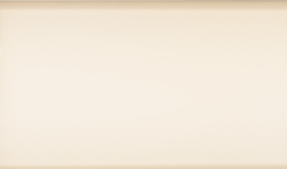
## SLR PROFIL BESTÜCKT MIT 2 X FLEXSTRIP 48 ODER 72 DW MIT EINEM LED ABSTAND VON 7,15MM IN KOMBINATION MIT DEN UNTERSCH. ABDECKUNGEN SLR PROFILE FITTED WITH 2 X FLEXSTRIP 48 OR 72 DW WITH A LED DISTANCE OF 7.15MM IN COMBINATION WITH THE DIFFERENT COVERS

PMMA Abdeckung SL Flach Transparent 91% Transmission	PMMA Abdeckung SL Flach Transp. 91% Transmission + Mikroprismatik Transp. 95% Transmission	PMMA Abdeckung SL Flach Transp. 91% Transmission + Mikroprismatik Opal 93% Transmission	PMMA Abdeckung SL Flach Opal 76% Transmission	PMMA Abdeckung SL Eckig Opal 76% Transmission
				
PMMA cover SL flat transparent 91% transmission	PMMA cover SL flat transparent 91% transmission + Microprismatic transparent 95% transmission	PMMA cover SL flat transparent 91% transmission + Microprismatic milky 93% transmission	PMMA cover SL flat milky 76% transmission	PMMA cover SL square milky 76% transmission

Netzteile mit max. 52mm Breite und 32mm Höhe im Profil integrierbar

Aluminium Abdeckung SL erforderlich!

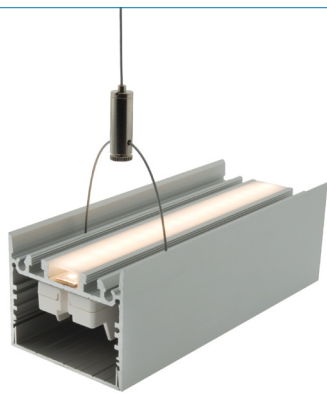

Power Supplies with max. 52mm width and 32mm height profile integrable

aluminum cover SL required!