

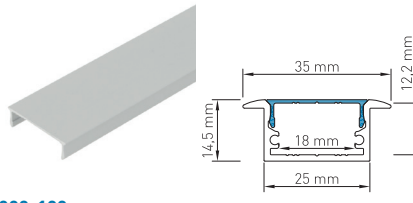











# LED Profil TBU | max. LED Leistung pro Meter: 28W → Flexstrip 115

ALUMINIUM PROFILE & ABDECKUNGEN   ALUMINIUM PROFILES & COVERS	
 <p><b>AP-002-004</b> Aluminium Profil TBU Aluminium profile TBU</p>	 <p><b>AB-002-100</b> Aluminium Abdeckung TB Aluminium cover TB</p>

PROFIL ABDECKUNGEN UND EINSCHÜBE   PROFILE COVERS AND INSETS		
 <p><b>AB-002-001</b> PMMA Abdeckung TB Flach Transparent PMMA cover TB flat transparent</p>	 <p><b>AB-002-003</b> PMMA Abdeckung TB Flach Opal PMMA cover TB flat milky</p>	 <p><b>AB-002-010</b> PMMA Abdeckung TB engstrahlend - Abstrahlwinkel 30° PMMA cover TB narrow beam - beam angle 30°</p>
 <p><b>AB-002-006</b> PMMA Abdeckung TB Rund opal PMMA cover TB round milky</p>	 <p><b>AB-002-009</b> PMMA Abdeckung TB Eckig Opal PMMA cover TB square milky</p>	 <p><b>AB-002-011</b> PMMA Abdeckung TB asymmetrisch - Abstrahlwinkel 45° PMMA cover TB asymmetrical - beam angle 45°</p>

PROFIL ENDKAPPEN   PROFILE ENDCAPS		
<p>Endkappenstärke   End cap thickness 2,5mm</p>  <p><b>EK-002-400</b> Profil Endkappe TBU Flach geschlossen Profile endcap TBU flat closed</p>	<p>Endkappenstärke   End cap thickness 2,5mm</p>  <p><b>EK-002-410</b> Profil Endkappe TBU Rund geschlossen Profile endcap TBU round closed</p>	<p>Endkappenstärke   End cap thickness 2,5mm</p>  <p><b>EK-002-420</b> Profil Endkappe TBU Eckig geschlossen Profile endcap TBU square closed</p>
<p>Endkappenstärke   End cap thickness 2,5mm</p>  <p><b>EK-002-401</b> Profil Endkappe TBU Flach mit Langloch Profile endcap TBU flat with cable entry</p>	<p>Endkappenstärke   End cap thickness 2,5mm</p>  <p><b>EK-002-411</b> Profil Endkappe TBU Rund mit Langloch Profile endcap TBU round with cable entry</p>	<p>Endkappenstärke   End cap thickness 2,5mm</p>  <p><b>EK-002-421</b> Profil Endkappe TBU Eckig mit Langloch Profile endcap TBU square with cable entry</p>

1m	2m	4m	SONDER LÄNGE	SPECIAL LENGTH
----	----	----	--------------	----------------

STANDARDLÄNGE = 2M | ALLE ANDEREN LÄNGEN SIND VOM UMTAUSCH UND DER RÜCKGABE AUSGESCHLOSSEN. LÄNGEN ÜBER 2M WERDEN MITTELS SPEDITION VERSENDET UND ERFORDERN EINE MINDESTBESTELLMENGE VON 10 STK.

STANDARD LENGTH = 2M | ALL OTHER LENGTHS ARE EXCLUDED FROM EXCHANGE AND RETURN. LENGTHS OVER 2M ARE SHIPPED BY FREIGHT CARRIER AND REQUIRE A MINIMUM ORDER QUANTITY OF 10 PCS.











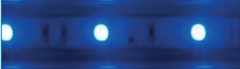
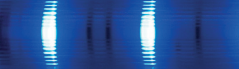

## HINWEIS PLEASE NOTE

Kunststoff und Aluminium besitzen unterschiedliche Ausdehnungskoeffizienten, welche bei der Montage zu berücksichtigen sind. Ausgehend von 20°C verändert sich die Länge beim Aluminium um ca. 0,25mm pro Meter und beim Kunststoff um ca. 0,70mm pro Meter je 10°C Temperaturunterschied.

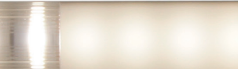
Plastic and aluminium have different expansion coefficients, which must be considered during assembly. Based on 20°C the length of aluminium changes approximately 0,25mm per meter and plastic approximately 0,70 mm per meter per 10°C of difference in temperature.

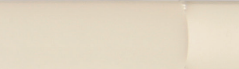
# LED Profile TBU | max. LED power per meter: 28W → Flexstrip 115

PROFIL ZUBEHÖR   PROFILE ACCESSORIES		
 <p><b>PZ-003-001</b> Einbau Montagewinkel LB und TB Mounting angel LB and TB</p>	 <p><b>PZ-006-001</b> Saugnapf 30mm Suction cup 30mm</p>	 <p><b>PZ-003-004</b> Einbau Montagewinkel TB Mounting angel TB</p>
 <p><b>EK-100-002</b> Torx Bit TX8 für Endkappenschrauben Torx Bit TX8 for endcap screws</p>	 <p><b>PZ-008-001</b> Einbau Montagefeder LB und TB Mounting spring LB and TB</p>	

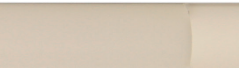
TBU PROFIL BESTÜCKT MIT FLEXSTRIP 36 RGB MIT EINEM LED ABSTAND VON 33MM IN KOMBINATION MIT DEN UNTERSCHIEDLICHEN ABDECKUNGEN TBU PROFILE FITTED WITH FLEXSTRIP 36 RGB WITH A LED DISTANCE OF 33MM IN COMBINATION WITH THE DIFFERENT COVERS				
PMMA Abdeckung TB Flach Transparent 91% Transmission	PMMA Abdeckung TB Engstrahlend 91% Transmission	PMMA Abdeckung TB Flach Opal 50% Transmission	PMMA Abdeckung TB Rund Opal 50% Transmission	PMMA Abdeckung TB Eckig Opal 57% Transmission
				
PMMA cover TB flat transparent 91% transmission	PMMA cover TB narrow beam 91% transmission	PMMA cover TB flat milky 50% transmission	PMMA cover TB round milky 50% transmission	PMMA cover TB square milky 57% transmission
TBU PROFIL BESTÜCKT MIT FLEXSTRIP 24 ODER 72 MIT EINEM LED ABSTAND VON 16,5MM IN KOMBINATION MIT DEN UNTERSCHIEDLICHEN ABDECKUNGEN TBU PROFILE FITTED WITH FLEXSTRIP 24 OR 72 WITH A LED DISTANCE OF 16,5MM IN COMBINATION WITH THE DIFFERENT COVERS				
PMMA Abdeckung TB Flach Transparent 91% Transmission	PMMA Abdeckung TB Engstrahlend 91% Transmission	PMMA Abdeckung TB Flach Opal 50% Transmission	PMMA Abdeckung TB Rund Opal 50% Transmission	PMMA Abdeckung TB Eckig Opal 57% Transmission
				
PMMA cover TB flat transparent 91% transmission	PMMA cover TB narrow beam 91% transmission	PMMA cover TB flat milky 50% transmission	PMMA cover TB round milky 50% transmission	PMMA cover TB square milky 57% transmission
TBU PROFIL BESTÜCKT MIT FLEXSTRIP 48 ODER 72 DW MIT EINEM LED ABSTAND VON 8,25MM IN KOMBINATION MIT DEN UNTERSCHIEDLICHEN ABDECKUNGEN TBU PROFILE FITTED WITH FLEXSTRIP 48 OR 72 DW WITH A LED DISTANCE OF 8.25MM IN COMBINATION WITH THE DIFFERENT COVERS				
PMMA Abdeckung TB Flach Transparent 91% Transmission	PMMA Abdeckung TB Engstrahlend 91% Transmission	PMMA Abdeckung TB Flach Opal 50% Transmission	PMMA Abdeckung TB Rund Opal 50% Transmission	PMMA Abdeckung TB Eckig Opal 57% Transmission
				
PMMA cover TB flat transparent 91% transmission	PMMA cover TB narrow beam 91% transmission	PMMA cover TB flat milky 50% transmission	PMMA cover TB round milky 50% transmission	PMMA cover TB square milky 57% transmission