









LED Profil TBR | max. LED Leistung pro Meter: 28W → Flexstrip 115

ALUMINIUM PROFILE & ABDECKUNGEN ALUMINIUM PROFILES & COVERS		
 <p>AP-002-002 Aluminium Profil TBR Aluminium profile TBR</p>	 <p>AB-002-100 Aluminium Abdeckung TB Aluminium cover TB</p>	 <p>AP-100-001 Aluminium Flachmaterial Aluminium flat material</p>

PROFIL ABDECKUNGEN UND EINSCHÜBE PROFILE COVERS AND INSETS		
 <p>AB-002-001 PMMA Abdeckung TB Flach Transparent PMMA cover TB flat transparent</p>	 <p>AB-002-003 PMMA Abdeckung TB Flach Opal PMMA cover TB flat milky</p>	 <p>AB-002-010 PMMA Abdeckung TB engstrahlend - Abstrahlwinkel 10° PMMA cover TB narrow beam - beam angle 10°</p>
 <p>AB-002-006 PMMA Abdeckung TB Rund opal PMMA cover TB round milky</p>	 <p>AB-002-009 PMMA Abdeckung TB Eckig Opal PMMA cover TB square milky</p>	 <p>AB-002-011 PMMA Abdeckung TB asymmetrisch - Abstrahlwinkel 13° PMMA cover TB asymmetrical - beam angle 13°</p>

PROFIL ENDKAPPEN PROFILE ENDCAPS		
<p>Endkappenstärke End cap thickness 2,5mm</p>  <p>EK-002-200 Profil Endkappe TBR Flach geschlossen Profile endcap TBR flat closed</p>	<p>Endkappenstärke End cap thickness 2,5mm</p>  <p>EK-002-210 Profil Endkappe TBR Rund geschlossen Profile endcap TBR round closed</p>	<p>Endkappenstärke End cap thickness 2,5mm</p>  <p>EK-002-220 Profil Endkappe TBR Eckig geschlossen Profile endcap TBR square closed</p>
<p>Endkappenstärke End cap thickness 2,5mm</p>  <p>EK-002-201 Profil Endkappe TBR Flach mit Langloch Profile endcap TBR flat with cable entry</p>	<p>Endkappenstärke End cap thickness 2,5mm</p>  <p>EK-002-211 Profil Endkappe TBR Rund mit Langloch Profile endcap TBR round with cable entry</p>	<p>Endkappenstärke End cap thickness 2,5mm</p>  <p>EK-002-221 Profil Endkappe TBR Eckig mit Langloch Profile endcap TBR square with cable entry</p>

1m	2m	4m	SONDER LÄNGE	SPECIAL LENGTH
----	----	----	--------------	----------------

STANDARDLÄNGE = 2M | ALLE ANDEREN LÄNGEN SIND VOM UMTAUSCH UND DER RÜCKGABE AUSGESCHLOSSEN. LÄNGEN ÜBER 2M WERDEN MITTELS SPEDITION VERSENDET UND ERFORDERN EINE MINDESTBESTELLMENGE VON 10 STK.











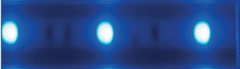
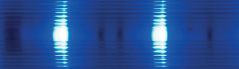

STANDARD LENGTH = 2M | ALL OTHER LENGTHS ARE EXCLUDED FROM EXCHANGE AND RETURN. LENGTHS OVER 2M ARE SHIPPED BY FREIGHT CARRIER AND REQUIRE A MINIMUM ORDER QUANTITY OF 10 PCS.

HINWEIS PLEASE NOTE

Kunststoff und Aluminium besitzen unterschiedliche Ausdehnungskoeffizienten, welche bei der Montage zu berücksichtigen sind. Ausgehend von 20°C verändert sich die Länge beim Aluminium um ca. 0,25mm pro Meter und beim Kunststoff um ca. 0,70mm pro Meter je 10°C Temperaturunterschied.

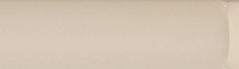
Plastic and aluminium have different expansion coefficients, which must be considered during assembly. Based on 20°C the length of aluminium changes approximately 0,25mm per meter and plastic approximately 0,70 mm per meter per 10°C of difference in temperature.

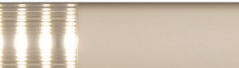
PROFIL ZUBEHÖR PROFILE ACCESSORIES				
 <p>PZ-001-002 Seilabhänger 2m inkl. Deckenbefestigung Wire suspension 2m incl. ceiling fixture</p> <p>PZ-001-005 Seilabhänger 5m inkl. Deckenbefestigung Wire suspension 5m incl. ceiling fixture</p>	 <p>PZ-002-001 Seilstopper inkl. M4 Senkkopfschraube Wire stopper incl. M4 countersunk screw</p>	 <p>PZ-006-001 Saugnapf 30mm Suction cup 30mm</p>		
 <p>PZ-007-001 Montagewinkel schwenkbar Mounting angle swivelling</p>	 <p>EK-100-002 Torx Bit TX8 für Endkappenschrauben Torx Bit TX8 for endcap screws</p>			

TBR PROFIL BESTÜCKT MIT FLEXSTRIP 36 RGB MIT EINEM LED ABSTAND VON 33MM IN KOMBINATION MIT DEN UNTERSCHIEDLICHEN ABDECKUNGEN TBR PROFILE FITTED WITH FLEXSTRIP 36 RGB WITH A LED DISTANCE OF 33MM IN COMBINATION WITH THE DIFFERENT COVERS				
<p>PMMA Abdeckung TB Flach Transparent 91% Transmission</p>	<p>PMMA Abdeckung TB Engstrahlend 91% Transmission</p>	<p>PMMA Abdeckung TB Flach Opal 50% Transmission</p>	<p>PMMA Abdeckung TB Rund Opal 50% Transmission</p>	<p>PMMA Abdeckung TB Eckig Opal 57% Transmission</p>
				
<p>PMMA cover TB flat transparent 91% transmission</p>	<p>PMMA cover TB narrow beam 91% transmission</p>	<p>PMMA cover TB flat milky 50% transmission</p>	<p>PMMA cover TB round milky 50% transmission</p>	<p>PMMA cover TB square milky 57% transmission</p>
TBR PROFIL BESTÜCKT MIT FLEXSTRIP 24 ODER 72 MIT EINEM LED ABSTAND VON 16,5MM IN KOMBINATION MIT DEN UNTERSCHIEDLICHEN ABDECKUNGEN TBR PROFILE FITTED WITH FLEXSTRIP 24 OR 72 WITH A LED DISTANCE OF 16,5MM IN COMBINATION WITH THE DIFFERENT COVERS				
<p>PMMA Abdeckung TB Flach Transparent 91% Transmission</p>	<p>PMMA Abdeckung TB Engstrahlend 91% Transmission</p>	<p>PMMA Abdeckung TB Flach Opal 50% Transmission</p>	<p>PMMA Abdeckung TB Rund Opal 50% Transmission</p>	<p>PMMA Abdeckung TB Eckig Opal 57% Transmission</p>
				
<p>PMMA cover TB flat transparent 91% transmission</p>	<p>PMMA cover TB narrow beam 91% transmission</p>	<p>PMMA cover TB flat milky 50% transmission</p>	<p>PMMA cover TB round milky 50% transmission</p>	<p>PMMA cover TB square milky 57% transmission</p>
TBR PROFIL BESTÜCKT MIT FLEXSTRIP 48 ODER 72 DW MIT EINEM LED ABSTAND VON 8,25MM IN KOMBINATION MIT DEN UNTERSCHIEDLICHEN ABDECKUNGEN TBR PROFILE FITTED WITH FLEXSTRIP 48 OR 72 DW WITH A LED DISTANCE OF 8.25MM IN COMBINATION WITH THE DIFFERENT COVERS				
<p>PMMA Abdeckung TB Flach Transparent 91% Transmission</p>	<p>PMMA Abdeckung TB Engstrahlend 91% Transmission</p>	<p>PMMA Abdeckung TB Flach Opal 50% Transmission</p>	<p>PMMA Abdeckung TB Rund Opal 50% Transmission</p>	<p>PMMA Abdeckung TB Eckig Opal 57% Transmission</p>
				
<p>PMMA cover TB flat transparent 91% transmission</p>	<p>PMMA cover TB narrow beam 91% transmission</p>	<p>PMMA cover TB flat milky 50% transmission</p>	<p>PMMA cover TB round milky 50% transmission</p>	<p>PMMA cover TB square milky 57% transmission</p>