

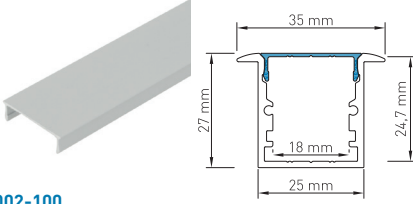







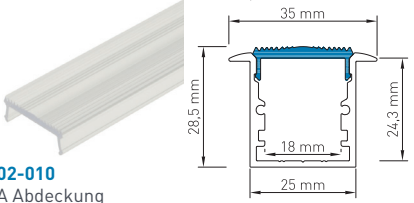

LED Profil TBI | max. LED Leistung pro Meter: 28W → Flexstrip 115

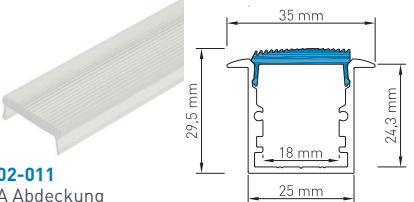
ALUMINIUM PROFILE & ABDECKUNGEN ALUMINIUM PROFILES & COVERS	
 <p>AP-002-003 Aluminium Profil TBI Aluminium profile TBI</p>	 <p>AB-002-100 Aluminium Abdeckung TB Aluminium cover TB</p>

PROFIL ABDECKUNGEN UND EINSCHÜBE PROFILE COVERS AND INSETS		
 <p>AB-002-001 PMMA Abdeckung TB Flach Transparent PMMA cover TB flat transparent</p>	 <p>AB-002-003 PMMA Abdeckung TB Flach Opal PMMA cover TB flat milky</p>	 <p>AB-002-010 PMMA Abdeckung TB engstrahlend - Abstrahlwinkel 10° PMMA cover TB narrow beam - beam angle 10°</p>
 <p>AB-002-006 PMMA Abdeckung TB Rund opal PMMA cover TB round milky</p>	 <p>AB-002-009 PMMA Abdeckung TB Eckig Opal PMMA cover TB square milky</p>	 <p>AB-002-011 PMMA Abdeckung TB asymmetrisch - Abstrahlwinkel 13° PMMA cover TB asymmetrical - beam angle 13°</p>

PROFIL ENDKAPPEN PROFILE ENDCAPS		
<p>Endkappenstärke End cap thickness 2,5mm</p>  <p>EK-002-300 Profil Endkappe TBI Flach geschlossen Profile endcap TBI flat closed</p>	<p>Endkappenstärke End cap thickness 2,5mm</p>  <p>EK-002-310 Profil Endkappe TBI Rund geschlossen Profile endcap TBI round closed</p>	<p>Endkappenstärke End cap thickness 2,5mm</p>  <p>EK-002-320 Profil Endkappe TBI Eckig geschlossen Profile endcap TBI square closed</p>
<p>Endkappenstärke End cap thickness 2,5mm</p>  <p>EK-002-301 Profil Endkappe TBI Flach mit Langloch Profile endcap TBI flat with cable entry</p>	<p>Endkappenstärke End cap thickness 2,5mm</p>  <p>EK-002-311 Profil Endkappe TBI Rund mit Langloch Profile endcap TBI round with cable entry</p>	<p>Endkappenstärke End cap thickness 2,5mm</p>  <p>EK-002-321 Profil Endkappe TBI Eckig mit Langloch Profile endcap TBI square with cable entry</p>

1m	2m	4m	SONDER LÄNGE	SPECIAL LENGTH
----	----	----	--------------	----------------

STANDARDLÄNGE = 2M | ALLE ANDEREN LÄNGEN SIND VOM UMTAUSCH UND DER RÜCKGABE AUSGESCHLOSSEN. LÄNGEN ÜBER 2M WERDEN MITTELS SPEDITION VERSENDET UND ERFORDERN EINE MINDESTBESTELLMENGE VON 10 STK.

STANDARD LENGTH = 2M | ALL OTHER LENGTHS ARE EXCLUDED FROM EXCHANGE AND RETURN. LENGTHS OVER 2M ARE SHIPPED BY FREIGHT CARRIER AND REQUIRE A MINIMUM ORDER QUANTITY OF 10 PCS.











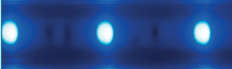



HINWEIS PLEASE NOTE

Kunststoff und Aluminium besitzen unterschiedliche Ausdehnungskoeffizienten, welche bei der Montage zu berücksichtigen sind. Ausgehend von 20°C verändert sich die Länge beim Aluminium um ca. 0,25mm pro Meter und beim Kunststoff um ca. 0,70mm pro Meter je 10°C Temperaturunterschied.

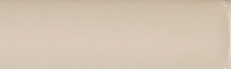
Plastic and aluminium have different expansion coefficients, which must be considered during assembly. Based on 20°C the length of aluminium changes approximately 0,25mm per meter and plastic approximately 0,70 mm per meter per 10°C of difference in temperature.

LED Profile TBI | max. LED power per meter: 28W → Flexstrip 115

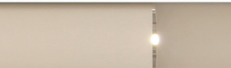
PROFIL ZUBEHÖR PROFILE ACCESSORIES		
 <p>PZ-003-001 Einbau Montagewinkel LB und TB Mounting angel LB and TB</p>	 <p>PZ-006-001 Saugnapf 30mm Suction cup 30mm</p>	 <p>PZ-003-004 Einbau Montagewinkel TB Mounting angel TB</p>
 <p>EK-100-002 Torx Bit TX8 für Endkappenschrauben Torx Bit TX8 for endcap screws</p>	 <p>PZ-008-001 Einbau Montagefeder LB und TB Mounting spring LB and TB</p>	

TBI PROFIL BESTÜCKT MIT FLEXSTRIP 36 RGB MIT EINEM LED ABSTAND VON 33MM IN KOMBINATION MIT DEN UNTERSCHIEDLICHEN ABDECKUNGEN TBI PROFILE FITTED WITH FLEXSTRIP 36 RGB WITH A LED DISTANCE OF 33MM IN COMBINATION WITH THE DIFFERENT COVERS				
PMMA Abdeckung TB Flach Transparent 91% Transmission	PMMA Abdeckung TB Engstrahlend 91% Transmission	PMMA Abdeckung TB Flach Opal 50% Transmission	PMMA Abdeckung TB Rund Opal 50% Transmission	PMMA Abdeckung TB Eckig Opal 57% Transmission
				
PMMA cover TB flat transparent 91% transmission	PMMA cover TB narrow beam 91% transmission	PMMA cover TB flat milky 50% transmission	PMMA cover TB round milky 50% transmission	PMMA cover TB square milky 57% transmission
TBI PROFIL BESTÜCKT MIT FLEXSTRIP 24 ODER 72 MIT EINEM LED ABSTAND VON 16,5MM IN KOMBINATION MIT DEN UNTERSCHIEDLICHEN ABDECKUNGEN TBI PROFILE FITTED WITH FLEXSTRIP 24 OR 72 WITH A LED DISTANCE OF 16,5MM IN COMBINATION WITH THE DIFFERENT COVERS				
PMMA Abdeckung TB Flach Transparent 91% Transmission	PMMA Abdeckung TB Engstrahlend 91% Transmission	PMMA Abdeckung TB Flach Opal 50% Transmission	PMMA Abdeckung TB Rund Opal 50% Transmission	PMMA Abdeckung TB Eckig Opal 57% Transmission
				
PMMA cover TB flat transparent 91% transmission	PMMA cover TB narrow beam 91% transmission	PMMA cover TB flat milky 50% transmission	PMMA cover TB round milky 50% transmission	PMMA cover TB square milky 57% transmission
TBI PROFIL BESTÜCKT MIT FLEXSTRIP 48 ODER 72 DW MIT EINEM LED ABSTAND VON 8,25MM IN KOMBINATION MIT DEN UNTERSCHIEDLICHEN ABDECKUNGEN TBI PROFILE FITTED WITH FLEXSTRIP 48 OR 72 DW WITH A LED DISTANCE OF 8,25MM IN COMBINATION WITH THE DIFFERENT COVERS				
PMMA Abdeckung TB Flach Transparent 91% Transmission	PMMA Abdeckung TB Engstrahlend 91% Transmission	PMMA Abdeckung TB Flach Opal 50% Transmission	PMMA Abdeckung TB Rund Opal 50% Transmission	PMMA Abdeckung TB Eckig Opal 57% Transmission
				
PMMA cover TB flat transparent 91% transmission	PMMA cover TB narrow beam 91% transmission	PMMA cover TB flat milky 50% transmission	PMMA cover TB round milky 50% transmission	PMMA cover TB square milky 57% transmission